

Trasformatori



•78PV200314/PS

Serie 7800



- Capacità alloggiamento fino a 17 moduli Din
- Spia rossa di presenza rete e griglia di aerazione
- Sezionatore portafusibili 32A per fusibili di tipo 10,3x38mm
- A richiesta protezioni mediante interruttori magnetotermici

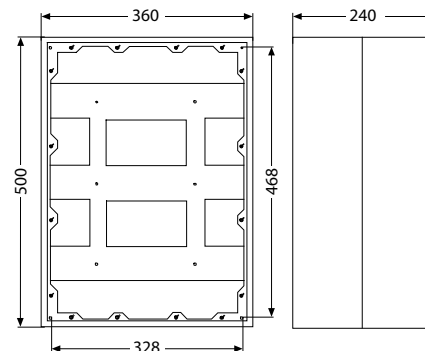

Dimensioni 360(x) x 500(y) x 240(z) mm

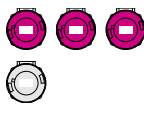
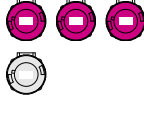
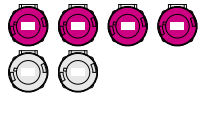
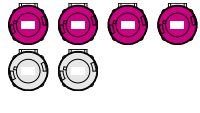
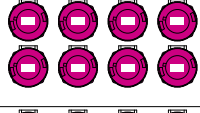
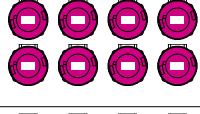
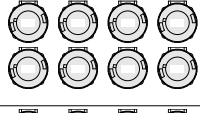
Articolo	Ingresso	Protezioni		Trasformatore Monofase	Uscite
		Primario	Secondario		
•78PV200314/PS	PM20	1 fusibile 10A ritardato	4 fusibili 16A rapidi	Primario: 230V Secondario: 24-48V Potenza: 2000VA	
78PV200314/PSV	PM20	1 fusibile 6A ritardato	4 fusibili 16A rapidi	Primario: 400V Secondario: 24-48V Potenza: 2000VA	
78PV250326/PS	PM20	1 fusibile 16A ritardato	4 fusibili 16A rapidi 2 fusibili 10A rapidi	Primario: 230V Secondario: 24-48V Potenza: 2500VA	
78PV250326/PSV	PM20	1 fusibile 8A ritardato	4 fusibili 16A rapidi 2 fusibili 10A rapidi	Primario: 400V Secondario: 24-48V Potenza: 2500VA	
78PV30028/PS	PM20	1 fusibile 16A ritardato	8 fusibili 16A rapidi	Primario: 230V Secondario: 24V Potenza: 3000VA	
78PV30028/PSV	PM20	1 fusibile 10A ritardato	8 fusibili 16A rapidi	Primario: 400V Secondario: 24V Potenza: 3000VA	
78PV30048/PS	PM20	1 fusibile 16A ritardato	8 fusibili 8A rapidi	Primario: 230V Secondario: 48V Potenza: 3000VA	
78PV30048/PSV	PM20	1 fusibile 10A ritardato	8 fusibili 8A rapidi	Primario: 400V Secondario: 48V Potenza: 3000VA	