

## Trasformatori



• 72PT02522/PS





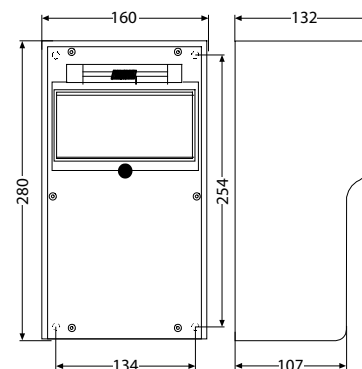

### Serie 7200



- Capacità alloggiamento fino a 7 moduli Din
- Spia rossa di presenza rete e griglia di aerazione
- Sezionatore portafusibili 32A per fusibili di tipo 10,3x38mm
- A richiesta protezioni mediante interruttori magnetotermici



Dimensioni 160(x) x 280(y) x 132(z) mm

Articolo	Ingresso	Protezioni		Trasformatore Monofase	Uscite	
		Primario	Secondario			
72PT01621/PS	PM20	1 fusibile 2A ritardato	1 fusibile 6A rapido	Primario: 230V Secondario: 24V Potenza: 160VA	1 CEE 24V 16A 2P IP67	
72PT01621/PSV	PM20	1 fusibile 1A ritardato	1 fusibile 6A rapido	Primario: 400V Secondario: 24V Potenza: 160VA	1 CEE 24V 16A 2P IP67	
72PT01641/PS	PM20	1 fusibile 2A ritardato	1 fusibile 4A rapido	Primario: 230V Secondario: 48V Potenza: 160VA	1 CEE 48V 16A 2P IP67	
72PT01641/PSV	PM20	1 fusibile 1A ritardato	1 fusibile 4A rapido	Primario: 400V Secondario: 48V Potenza: 160VA	1 CEE 48V 16A 2P IP67	
• 72PT02522/PS	PM20	1 fusibile 2A ritardato	1 fusibile 10A rapido	Primario: 230V Secondario: 24V Potenza: 250VA	2 CEE 24V 16A 2P IP67	
72PT02521/PSV	PM20	1 fusibile 2A ritardato	1 fusibile 10A rapido	Primario: 400V Secondario: 24V Potenza: 250VA	1 CEE 24V 16A 2P IP67	
72PT02541/PS	PM20	1 fusibile 2A ritardato	1 fusibile 6A rapido	Primario: 230V Secondario: 48V Potenza: 250VA	1 CEE 48V 16A 2P IP67	
72PT02541/PSV	PM20	1 fusibile 1A ritardato	1 fusibile 6A rapido	Primario: 400V Secondario: 48V Potenza: 250VA	1 CEE 48V 16A 2P IP67	